

RKHD-220 Variable Speed Electrical Schematics

460-3-60 UL

Operating Voltage 460 VAC
Auxillary Voltage 24 VAC
Frequency 60 Hz
Degree of Protection IP20

Document Number 141044.01

UL508A/CSA22.2

Page	Title
1	LIST OF SYMBOLS
2	POWER DISTRIBUTION
3	INVERTER SUPPLY
4	MOTOR STARTING
5	INVERTER COMMAND
6	24VAC/DC AUXILIARIES
7	CONTROL BOARD LAYOUT
8	24VAC AUXILIARIES
9	TERMINAL BLOCK
10	LAYOUT

List of Symbols

LABEL	DESCRIPTION	POSITION
A1	PANEL OPERATOR	10/A1
F2	FAN MOTOR M2 PROTECTION FUSES	3/B4
F3	FAN MOTOR M3 PROTECTION FUSES	3/B5
F4	PROTECTION FUSES	3/B6
F4A	PROTECTION FUSES 110VAC	3A/B6
F5	TRANSFORMER T1 PROTECTION FUSES	3/B7
F6	POWER TRANSFORMER T2 PROTECTION FUSES	3/B8
F7	FAN MOTOR M4 PROTECTION FUSES	4/A6
F8	FAN MOTOR M5 PROTECTION FUSES	4/B8
F9	POWER SUPPLY CONVERTER FUSES	6/C1
F10	PROTECTION FUSE 24VDC	6/D3
F11	CONTROL PROTECTION FUSE	6/B5
F12	CONTROLBOARD PROTECTION FUSE	6/B6
FM1	OVERLOAD PROTECTION INTERNAL MOTOR M1	3A/E2
FM2	OVERLOAD PROTECTION FAN MOTOR M2	4/D3
FM3	OVERLOAD PROTECTION FAN MOTOR M3	4/D4
FM4	OVERLOAD PROTECTION FAN MOTOR M4	4/D6
FM5	OVERLOAD PROTECTION FAN MOTOR M5	4/D8
G1	SUPPLY CONVERTER AC/DC	6/B3
KM2	MOTOR M2 CONTACTOR	8/B3
KM3	MOTOR M3 CONTACTOR	8/B3
KM4	MOTOR M4 CONTACTOR	8/B4
KM5	MOTOR M5 CONTACTOR	8/B4
M1	MOTOR COMPRESSOR	3A/E3
M2	FAN MOTOR COMPRESSOR	4/E3
M3	EXTRACTION AIR CABINET	4/E4
M4	COOLING OIL	4/E6
M5	COOLING AIR	4/E8
PS1	PRESSURE SENSOR-2	8/E4
PS2	PRESSURE SENSOR-1	8/E4
Q...	EXTERNAL MAIN SWITCH	3/A1
R1	TEMPERATURE SENSOR-2	8/F3
R2	TEMPERATURE SENSOR-1	8/F3
S1	SAFETY BUTTON	8/A5
T1	TRANSFORMER	6/B5
T2	POWER TRANSFORMER	6/B1
T3	TRANSFORMER	3A/B6
U1	CONTROL BOARD FREQUENCY CONVERTER	5/B1
U1	FREQUENCY CONVERTER	3A/C3
Y1	LOAD/UNLOAD	8/B5



support@pneutech.com
888.966.9007 • PneuTech.com

Power Distribution

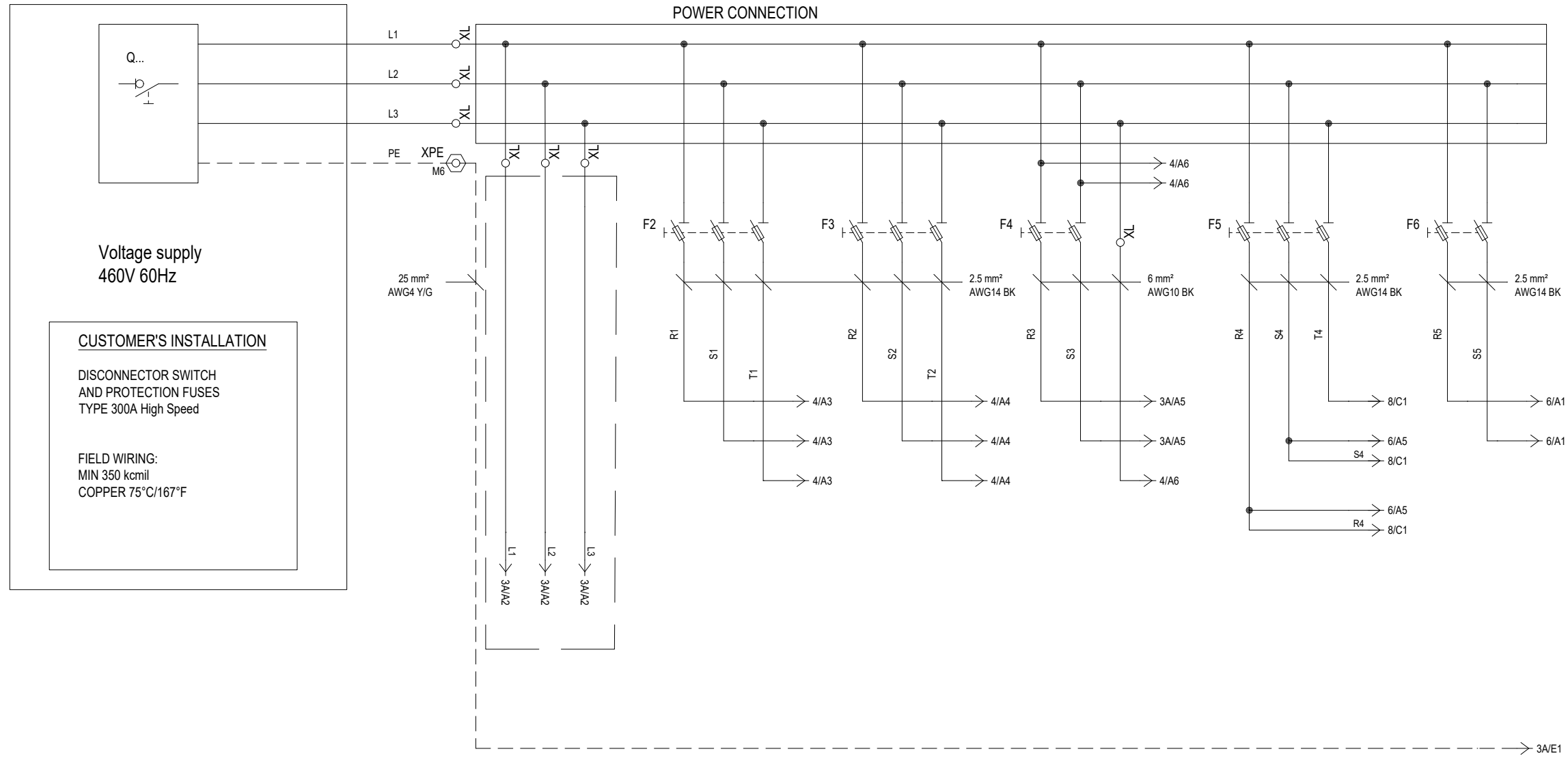

Voltage supply
460V 60Hz

CUSTOMER'S INSTALLATION

DISCONNECTOR SWITCH
AND PROTECTION FUSES
TYPE 300A High Speed

FIELD WIRING:
MIN 350 kcmil
COPPER 75°C/167°F

034 188 UL 034 292 UL	[hp - kW]	[V]	[A]	SET MAX [A]
M1	250 - 160	460	235.0	X
M2	1 - 0.75	460	1.7	FM2: 1.9
M3	3 - 2.2	460	4.18	FM3: 4.8
M4	3 - 2.2	460	4.18	FM4: 4.8
M5	0.5 - 0.37	460	0.90	FM5: 1.0

Wires available from: 3.1



support@pneutech.com
888.966.9007 • Pneutech.com

Inverter Power Supply

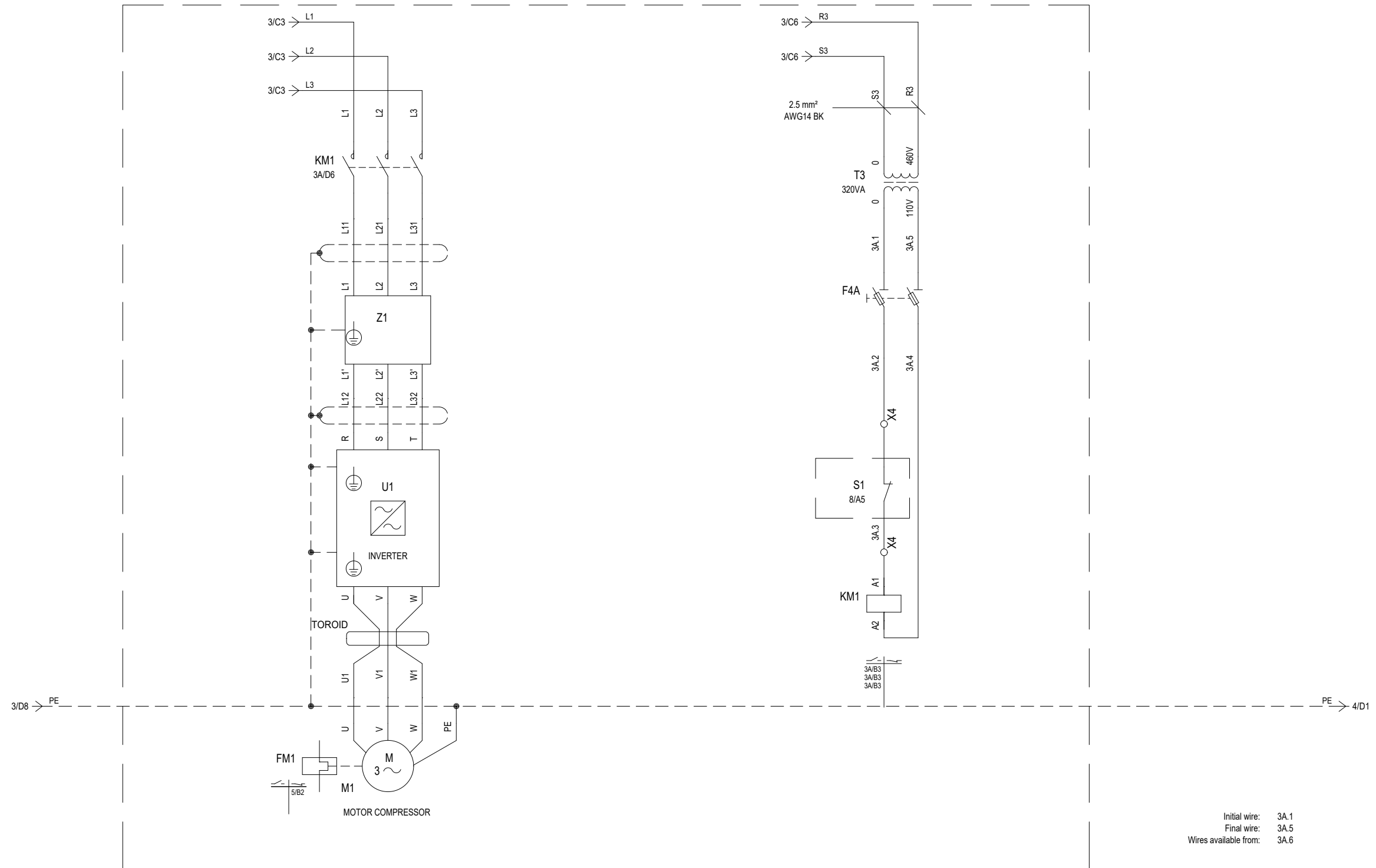

Motor Starting

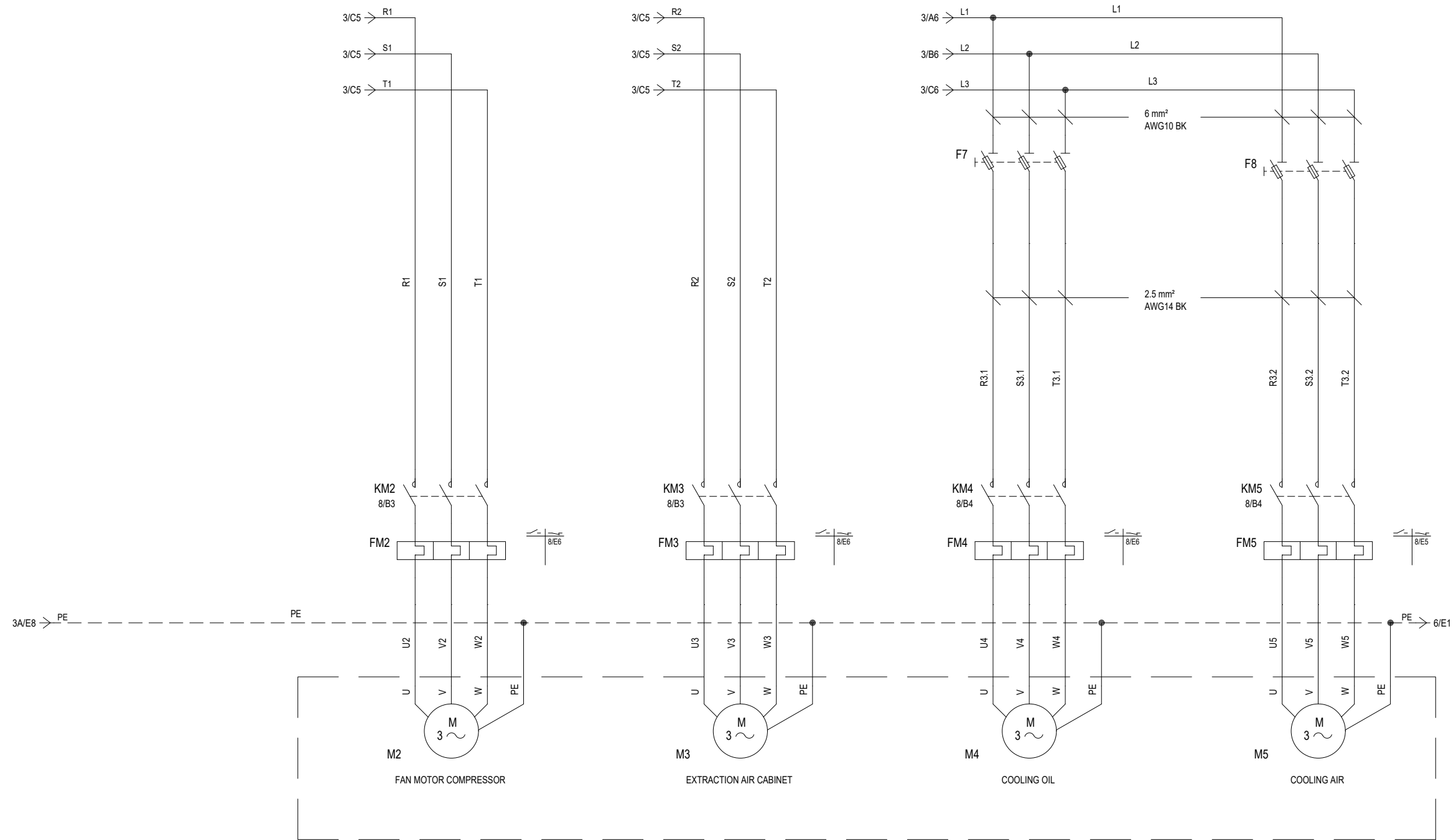

Wires available from: 4.1

RKHD-220 Variable Speed - Electrical Schematics

Inverter Command

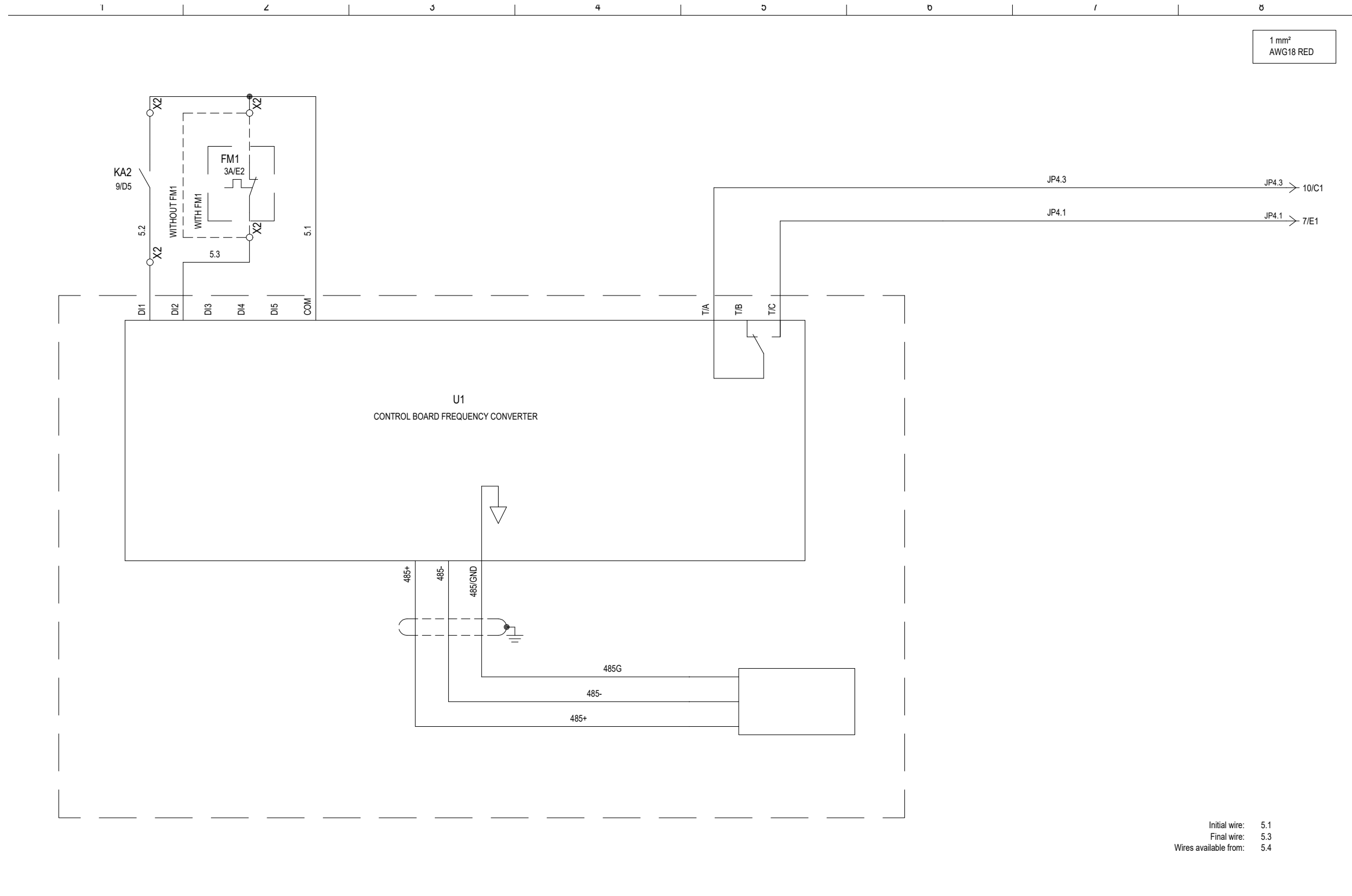

support@pneutech.com
888.966.9007 • PneuTech.com

RKHD-220 Variable Speed - Electrical Schematics

24VAC/DC Auxiliaries

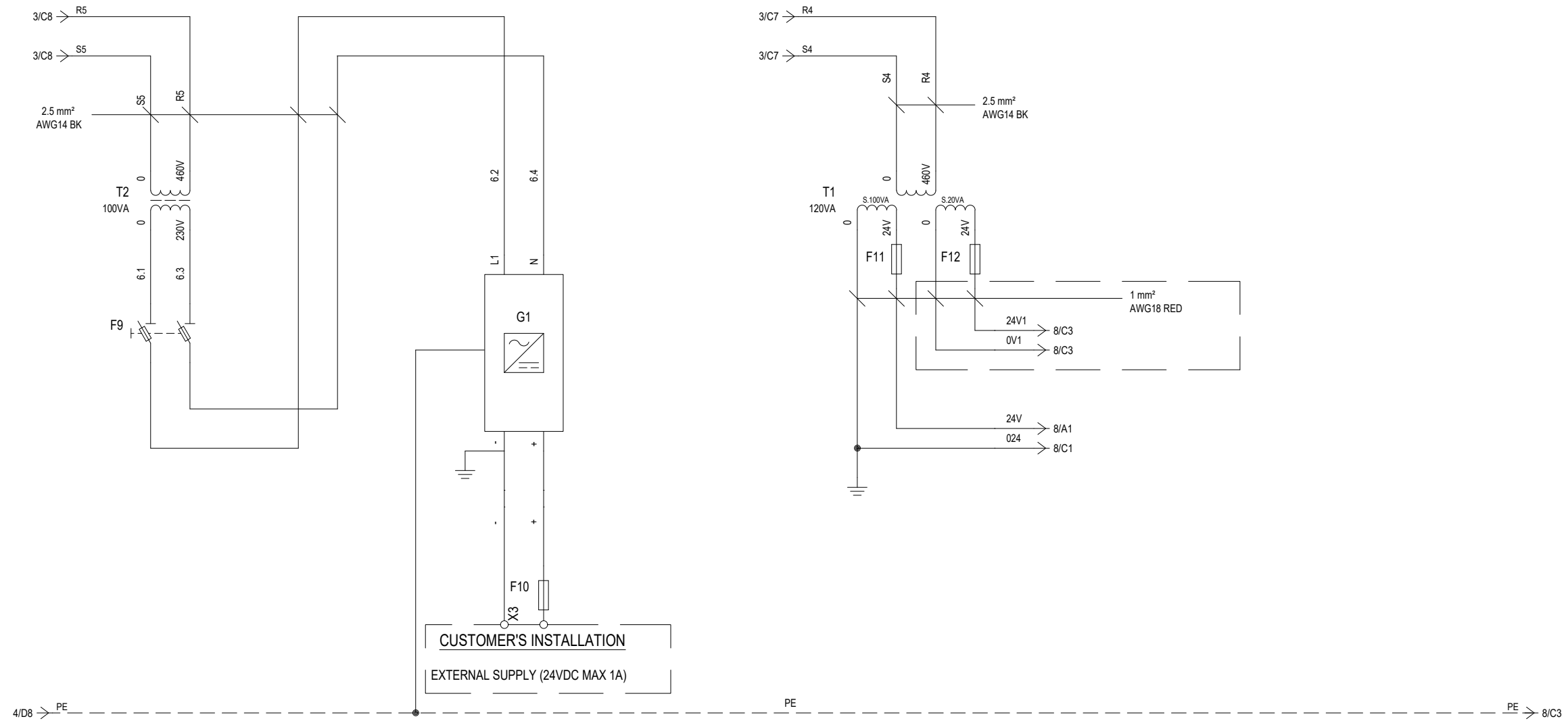

Initial wire: 6.1
 Final wire: 6.4
 Wires available from: 6.5



support@pneutech.com
 888.966.9007 • PneuTech.com

RKHD-220 Variable Speed - Electrical Schematics

Control Board Layout

1 mm²
AWG18 RED

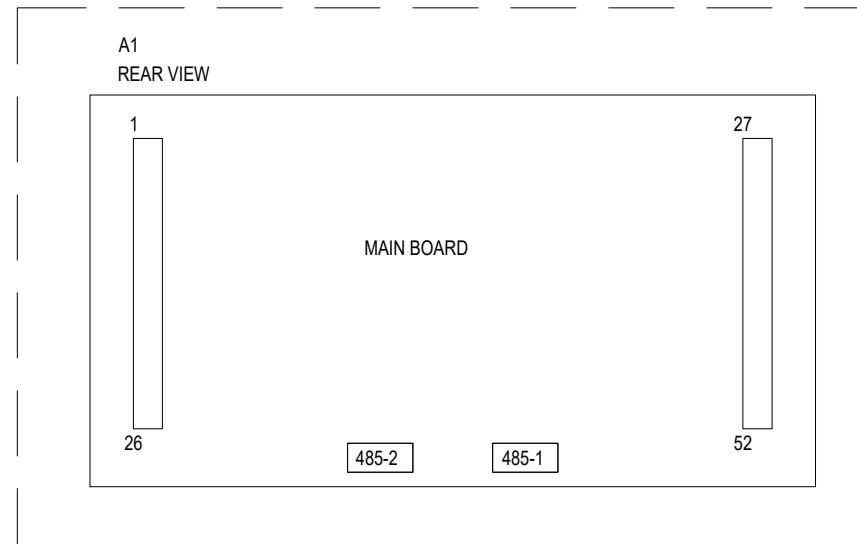

RKHD-220 Variable Speed - Electrical Schematics

24VAC/DC Auxiliaries

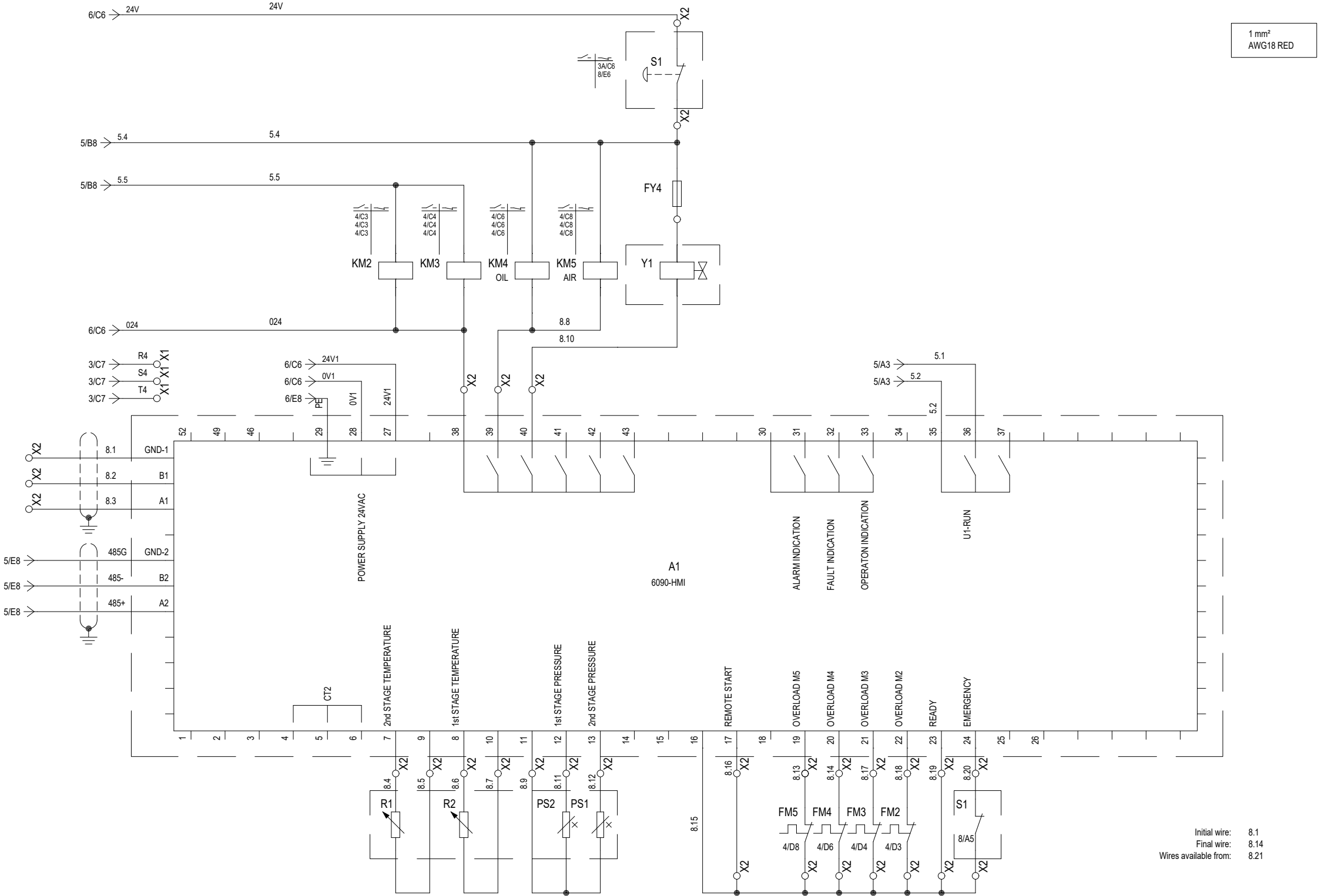

support@pneutech.com
888.966.9007 • PneuTech.com

RKHD-220 Variable Speed - Electrical Schematics

Terminal

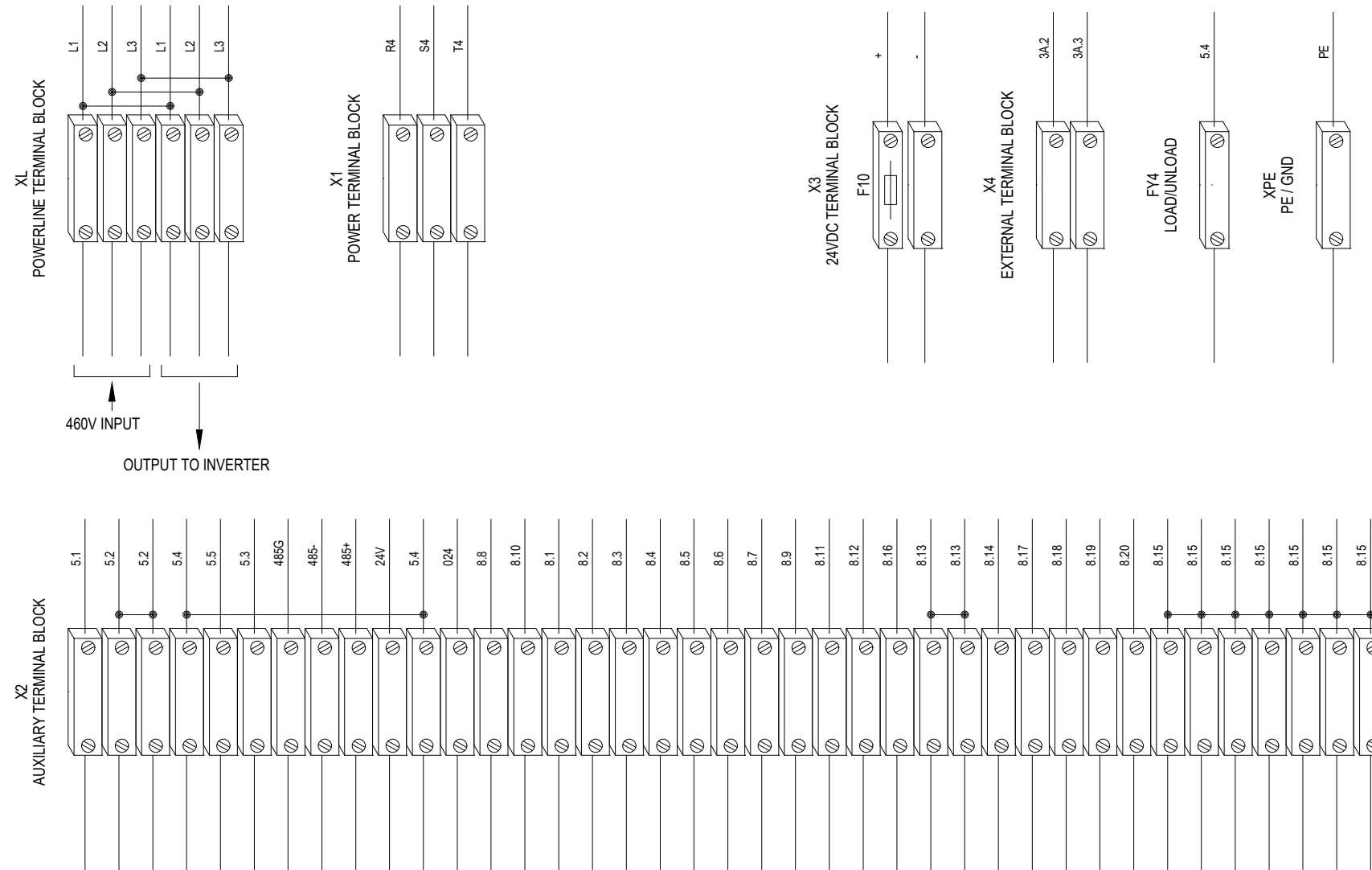

Layout

